

STEEL WALL POOL SYSTEM

15' ROUND

DWG #: GS-9757-DB	DATE: 8/3/2023	REV: -	PAGE 1 OF 3
AREA (SqFt): 177	PERIMETER: 47	EST. VOL (US Gal): TBD	

15 ROUND INGROUND KIT

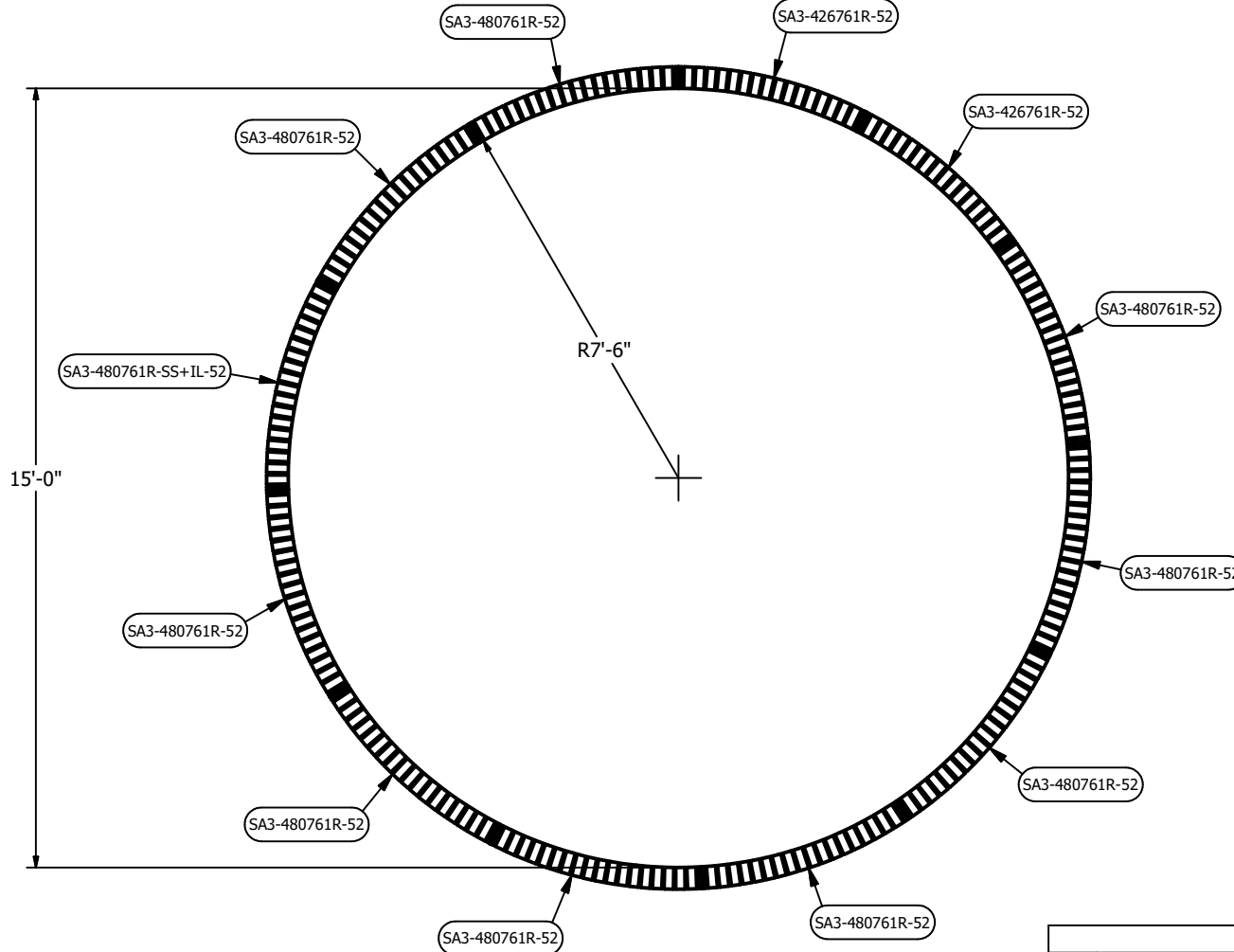

RADIUS STEP OPTION
SEE INSTALL GUIDE FOR
INSTALLATION

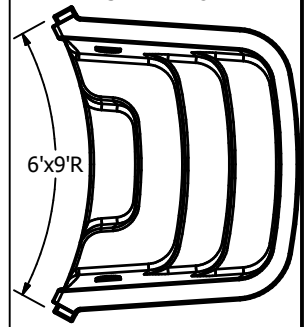

K2FS-1500R6B - BLUE
K2FS-1500R6G - GREY
K2FS-1500R6W - WHITE

BILL OF MATERIALS		
QT	PART NUMBER	DESCRIPTION
2	SA3-426761R-52	Stl Pnl 42 3/4" x 7'-6"R (52" Tall)-1 Rib
9	SA3-480761R-52	Stl Pnl 48" x 7'-6"R (52" Tall)- 1 Rib
1	SA3-480761R-SS+IL-52	Stl Pnl 48" x 7'-6" R Skim(1084)+Inlet Left (52" Tall)-1 Rib

BRACE / HARDWARE OPTIONS		
QTY	PART NUMBER	DESCRIPTION
1	HW-2002	Hdw Steel/Rrd Kit
1	HW-2013	Hdw Steel Add-on Kit (3/8" Bolts-100, 3/8" Nuts-100)

COPING		
QTY	PART NUMBER	DESCRIPTION
1	HW-2012	Hdw No-Diving Plate(7/Bag)
1	HW-1007	Hdw 12x1" Tek Screws - 100/Box
1	ATG-1001G	Alu Txt Clips - Grey - 15/Bag
1	ATG-960764RG	Alu Txt 8'x7' 6"R Bullnose Std - Grey -4/Box
2	ATG-960761RG	Alu Txt 8'x7'6"R Bull Std-Grey-1/Box

NO DIVING DANGER: DIVING MAY RESULT IN SERIOUS INJURY OR DEATH. Signage must be permanently attached around the perimeter of the pool.

THIS DOCUMENT IS FOR ILLUSTRATIVE PURPOSES ONLY. Original Equipment Manufacturer makes only those representations which are stated in its written warranty. Any other representations, statements, or contracts made by the dealer/contractor to the customer regarding any components produced by Original Equipment Manufacturer are attributable to the dealer/contractor only. The dealer or contractor who sells or installs your pool is an independent contractor and is not an agent or employee of Original Equipment Manufacturer. The construction methods illustrated here are suggestions and apply only to normal ground conditions. There may be additional precautions and/or methods of construction. The responsibility is the contractor's. -A safety line, with buoys, is to be permanently attached 1'-0" to the shallow side of the point of first slope change. -Different methods and precautions may be dictated by various ground conditions. This is to be determined by and is the responsibility of the contractor who is not an agent of the manufacturer of the component parts. -Installation is to be done in accordance with all federal, state and local building codes, as well as A.N.S.I./N.S.P.I. suggested standards. -BOTTOM SPECIFICATIONS MUST MEET OR EXCEED A.N.S.I./N.S.P.I./A.P.S.P. RECOMMENDED STANDARDS. -NO DIVING signage must be permanently attached to the entire perimeter of the pool. See instructions with signage. -IT IS RECOMMENDED TO NOT INSTALL DIVING BOARDS AND/OR SLIDING EQUIPMENT ON RESIDENTIAL POOLS. If diving boards and/or sliding equipment is installed by the contractor, such diving boards and sliding equipment MUST BE INSTALLED WITHIN THE GUIDELINES ESTABLISHED BY ANSI/NSPI/ASPA RECOMMENDED STANDARDS, AND IN ACCORDANCE WITH ALL APPLICABLE STATE AND LOCAL CODES AND REGULATIONS.



STEEL WALL POOL SYSTEM

15' ROUND

DWG #: GS-9757-DB	DATE: 8/3/2023	REV: -	PAGE 2 OF 3
AREA (SqFt): 177	PERIMETER: 47	EST. VOL (US Gal): TBD	

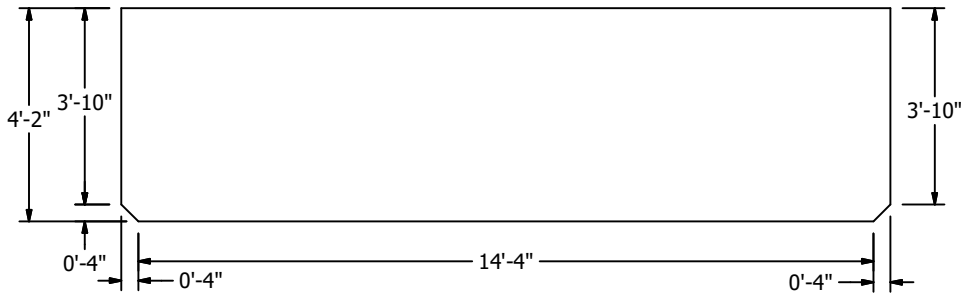
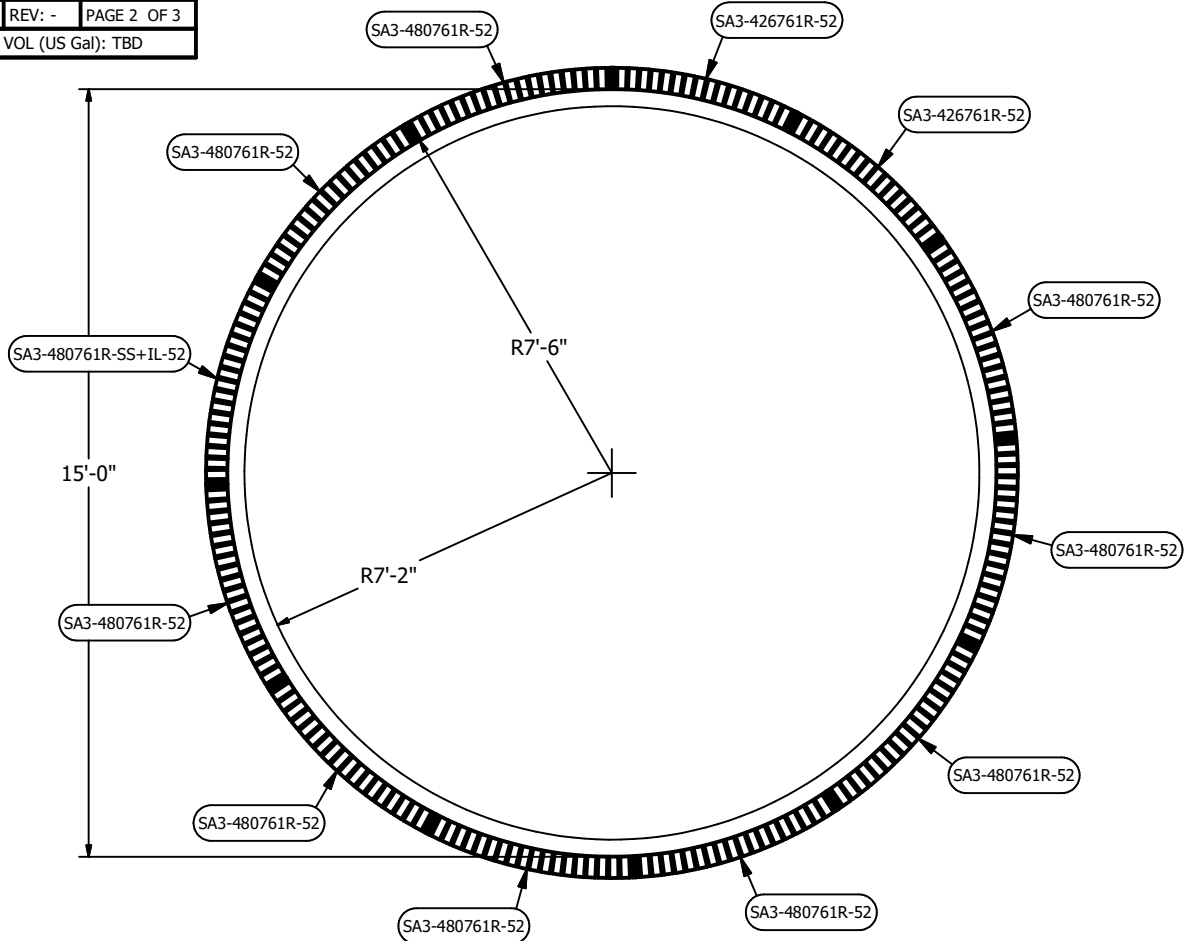

ST-1020ENB-52
(SIDE PROFILE)

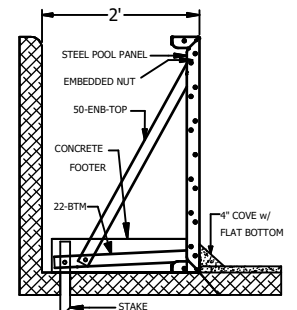

NO DIVING DANGER: DIVING MAY RESULT IN SERIOUS INJURY OR DEATH. Signage must be permanently attached around the perimeter of the pool.

THIS DOCUMENT IS FOR ILLUSTRATIVE PURPOSES ONLY. Original Equipment Manufacturer makes only those representations which are stated in its written warranty. Any other representations, statements, or contracts made by the dealer/contractor to the customer regarding any components produced by Original Equipment Manufacturer are attributable to the dealer/contractor only. The dealer or contractor who sells or installs your pool is an independent contractor and is not an agent or employee of Original Equipment Manufacturer. The construction methods illustrated here are suggestions and apply only to normal ground conditions. There may be additional precautions and/or methods of construction. The responsibility is the contractor's. -A safety line, with buoys, is to be permanently attached 1'-0" to the shallow side of the point of first slope change. -Different methods and precautions may be dictated by various ground conditions. This is to be determined by and is the responsibility of the contractor who is not an agent of the manufacturer of the component parts. -Installation is to be done in accordance with all federal, state and local building codes, as well as A.N.S.I./N.S.P.I. suggested standards. -BOTTOM SPECIFICATIONS MUST MEET OR EXCEED A.N.S.I./N.S.P.I./A.P.S.P. RECOMMENDED STANDARDS -NO DIVING signage must be permanently attached to the entire perimeter of the pool. See instructions with signage. -IT IS RECOMMENDED TO NOT INSTALL DIVING BOARDS AND/OR SLIDING EQUIPMENT ON RESIDENTIAL POOLS. IF diving boards and/or sliding equipment is installed by the contractor, such diving boards and sliding equipment MUST BE INSTALLED WITHIN THE GUIDELINES ESTABLISHED BY ANSI/NSPI/ASPA RECOMMENDED STANDARDS, AND IN ACCORDANCE WITH ALL APPLICABLE STATE AND LOCAL CODES AND REGULATIONS.



STEEL WALL POOL SYSTEM

15' ROUND

DWG #: GS-9757-DB	DATE: 8/3/2023	REV: -	PAGE 3 OF 3
AREA (SqFt): 177	PERIMETER: 47	EST. VOL (US Gal): TBD	

K2FS-1500R6RB - BLUE
 K2FS-1500R6RG - GREY
 K2FS-1500R6RW - WHITE
 (KIT CONTAINS x1 SA3F-1260R-52 PANEL WHICH CAN BE USED IN COMBINATION TO ACCOMODATE 6'R STEP)

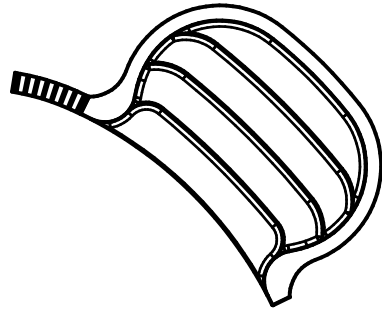

OPTION
 (REPLACE x1 42 3/4" & x1 48" RADIUS PANEL ON ANY SIDE)

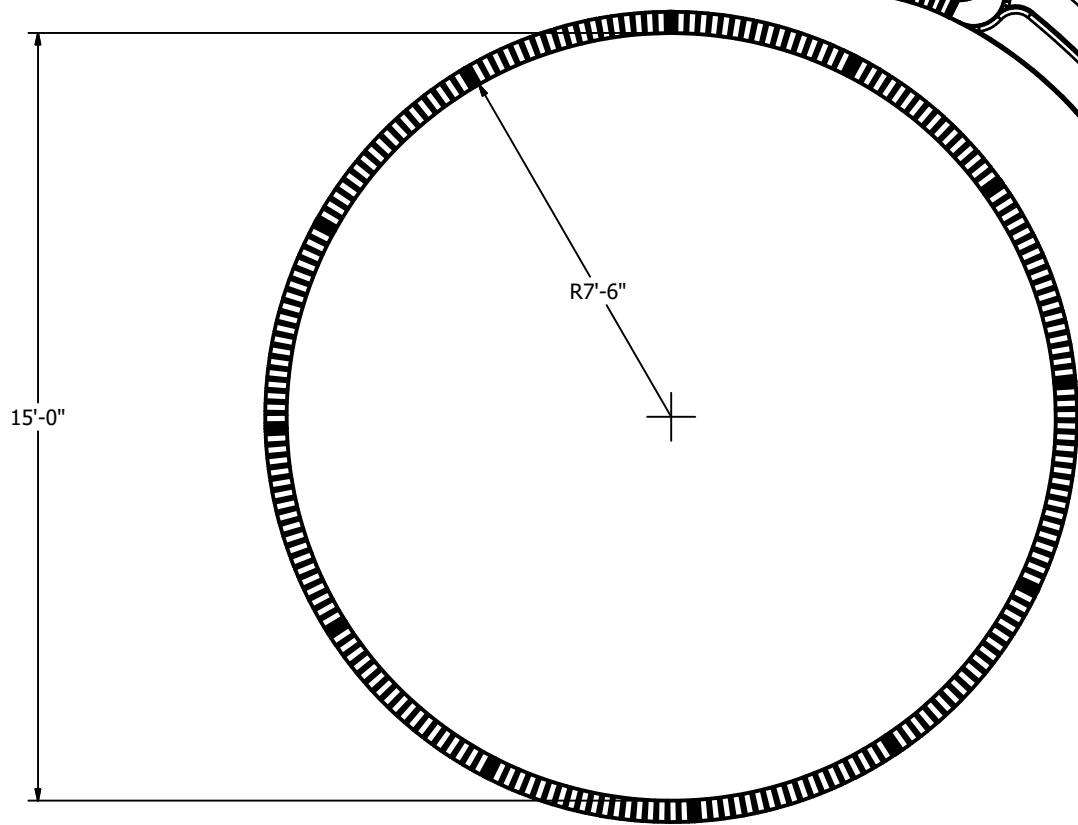
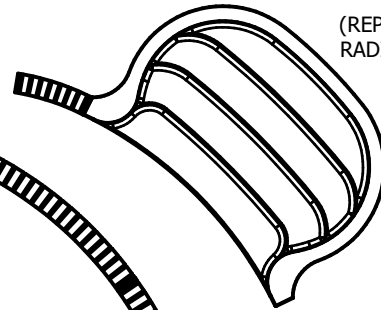

ST-1020ENB-52
 (SIDE PROFILE)

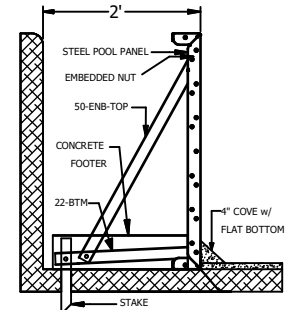

NO DIVING DANGER: DIVING MAY RESULT IN SERIOUS INJURY OR DEATH. Signage must be permanently attached around the perimeter of the pool.

THIS DOCUMENT IS FOR ILLUSTRATIVE PURPOSES ONLY. Original Equipment Manufacturer makes only those representations which are stated in its written warranty. Any other representations, statements, or contracts made by the dealer/contractor to the customer regarding any components produced by Original Equipment Manufacturer are attributable to the dealer/contractor only. The dealer or contractor who sells or installs your pool is an independent contractor and is not an agent or employee of Original Equipment Manufacturer. The construction methods illustrated here are suggestions and apply only to normal ground conditions. There may be additional precautions and/or methods of construction. The responsibility is the contractor's. -A safety line, with buoys, is to be permanently attached 1'-0" to the shallow side of the point of first slope change. -Different methods and precautions may be dictated by various ground conditions. This is to be determined by and is the responsibility of the contractor who is not an agent of the manufacturer of the component parts. -Installation is to be done in accordance with all federal, state and local building codes, as well as A.N.S.I./N.S.P.I. suggested standards. -BOTTOM SPECIFICATIONS MUST MEET OR EXCEED A.N.S.I./N.S.P.I./A.P.S.P. RECOMMENDED STANDARDS. -NO DIVING signage must be permanently attached to the entire perimeter of the pool. See instructions with signage. -IT IS RECOMMENDED TO NOT INSTALL DIVING BOARDS AND/OR SLIDING EQUIPMENT ON RESIDENTIAL POOLS. If diving boards and/or sliding equipment is installed by the contractor, such diving boards and sliding equipment MUST BE INSTALLED WITHIN THE GUIDELINES ESTABLISHED BY ANSI/NSPI/ASPA RECOMMENDED STANDARDS, AND IN ACCORDANCE WITH ALL APPLICABLE STATE AND LOCAL CODES AND REGULATIONS.

